



Installation Instructions

TWSD16128PHC





Introduction

The TWSD16128PHC is intended to be used with WLAN / Networking devices. The TWSD16128PHC is intended to be used both indoors and outdoors and to provide NEMA 3R protection with cooling and heating.

Maximum internal ambient is 45 Degrees Celsius.

Before installing this product, read these instructions carefully. Failure to follow these instructions could lead to damaging the product or cause a hazardous condition.

Check the ratings on the products you intend to place inside the enclosure solution to ensure that this is suitable for your application.

Precautions

Read and understand all instructions before you begin installing the unit

When installing and using this product, basic safety precautions should always be followed to reduce the risk of electric shock, fire and injury to persons including the following:

All wiring that connects to this equipment must meet applicable local and national building codes and network wiring standards for communications cable.

WARNING: To prevent the risk of electric shock and equipment damage, disconnect any and all supply mains connection to the enclosure before installing, maintaining or trouble shooting this product or any products inside the enclosure.

Retain the instructions for future reference.

Follow all warnings and instructions marked on the product.

Insulation on all cables and wires installed the service center must either be PVC, TFE, PTFE, FEP, Neoprene, or Polyimide.

Never install cable, connectors or jacks in a wet location unless they are specifically designed for wet locations.

Never install this product during a lightning storm. There is a risk of electric shock from lightning.

Never touch uninsulated communication wires or terminals.

Disconnect power before cleaning or servicing the unit.



Do not use liquid cleaners or aerosol cleaners; use a damp cloth for cleaning.

Mount the unit according to these instructions only using the recommended or supplied hardware.

Wear proper eye protection when using power and hand tools. Follow all safety instructions provided with the tools.

This unit should only be connected to the type of power source indicated. If you are unsure of the type of power supply, consult the local power company.

WARNING: Do not overload outlets as this can result in a risk of fire or electrical shock.

Disconnect power should any of the following conditions occur:

- The TWSD16128PHC does not operate normally when following the operating instructions
- The TWSD16128PHC has been damaged
- The TWSD16128PHC exhibits a distinct change in performance.

Heater / FAN

The TWSD16128PHC includes a heating element as well as a cooling fan to provide protection to the internal components from extreme temperatures.

CAUTION– Never touch the moving parts of the fan while in operation. Never touch the heat synch of the heating element while in operation – the heat synch becomes very hot while in operation and could cause personal injury if touched.

Warning

WARNING: To prevent the risk of electric shock and equipment damage, disconnect any and all power supply to the enclosure before installing, maintaining or trouble shooting this product or any products inside the enclosure.

Installation Instructions

Installation Environment

The TWSD16128PHC is intended for both indoor and outdoor use.

Maximum internal ambient is 45 Degrees Celsius.



Always mount the enclosure with the cord gland facing down (figure 6). Failure to do so could result in the unit filling with water – this could result in a hazardous condition and failure of the unit.

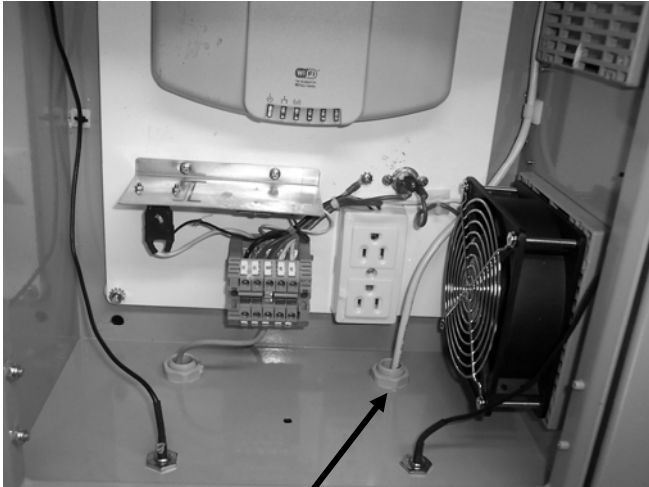

(Figure 6)

Cord Gland should face down to ground

WARNING: To prevent the risk of electric shock and equipment damage, disconnect any and all power supplies to the enclosure before installing, maintaining or trouble shooting this product or any products inside the enclosure.

Included Components

The TWSD16128PHC consists of the following components:

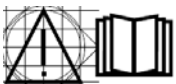

- NEMA 4 Plug
- Cooling Thermostat
- Heating Thermostat
- Heater
- Cooling Fan
- Mounting plate
- Power socket
- Terminal Block
- Cord Gland
- Cable Tie Downs



Customer will be required to install Conduit for Ethernet. Conduit should be suitable for environment used and wet applications.

Customer Supplied Items

Customers are required to provide their own mounting hardware. TerraWave recommends 3/8 inch fasteners, washers, lock washers and nuts. See figure 2.

Installing WLAN / Networking Components

The TWSD16128PHC will accommodate WLAN / Networking products to be installed inside the unit. This equipment should be installed on the mounting plate in the unit.

Wire / Cable Routing

The TWSD16128PHC comes with cable routing tie downs. These tie downs are used to provide convenient cable routing. It is important to use these cable tie downs to ensure that the cables that you install are kept away from the other components within the enclosure. Refer to figure 3 below to illustrate the use of these tie downs.

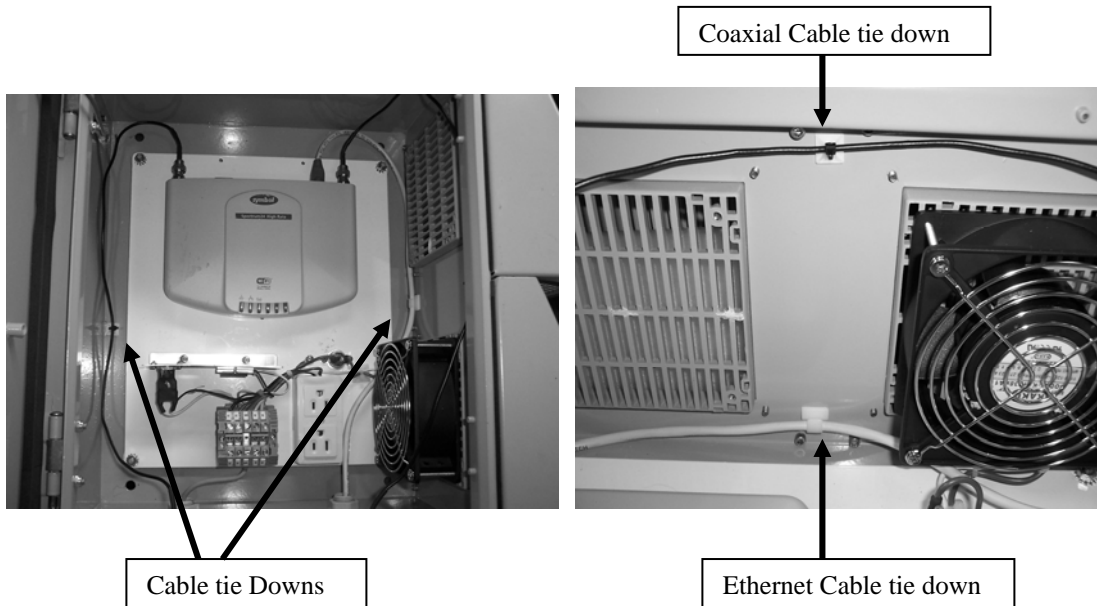

(Figure 3)

Ethernet Cable



When installing Ethernet cabling into the TWSD16128PHC, you must remove the pre-installed NEMA 4 plug in the bottom of the enclosure. To remove the plug, simply loosen the fly nut located inside the unit. Once the Fly nut has been removed, the plug will fall out of the enclosure. Replace the plug with conduit. The conduit must be suitable for environmental and wet locations. Refer the NEC and follow any national or local codes. Refer to figure 4 below.

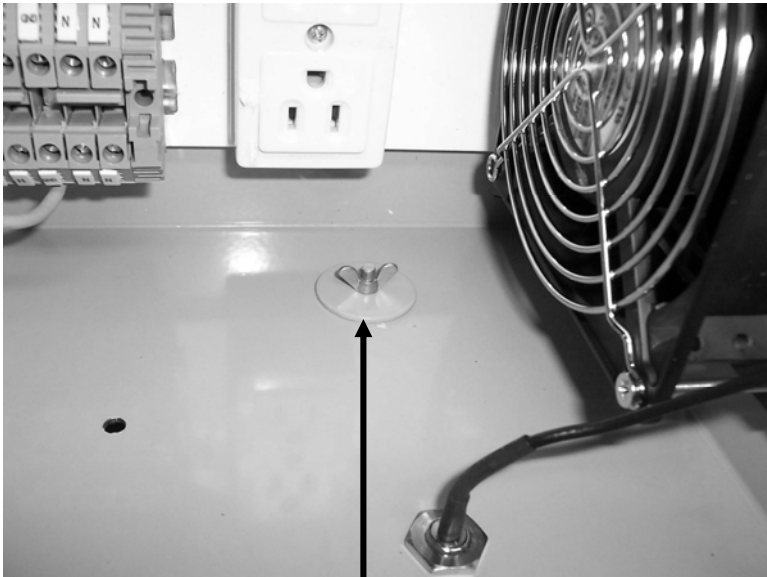

(Figure 4)

NEMA 4 Plug with Fly Nut

Mounting Plate

The TWSD16128PHC is supplied with a mounting plate to be used for attaching WLAN / Networking components. The following diagram (figure 1) shows which holes should be used when attaching approved products to the plate.

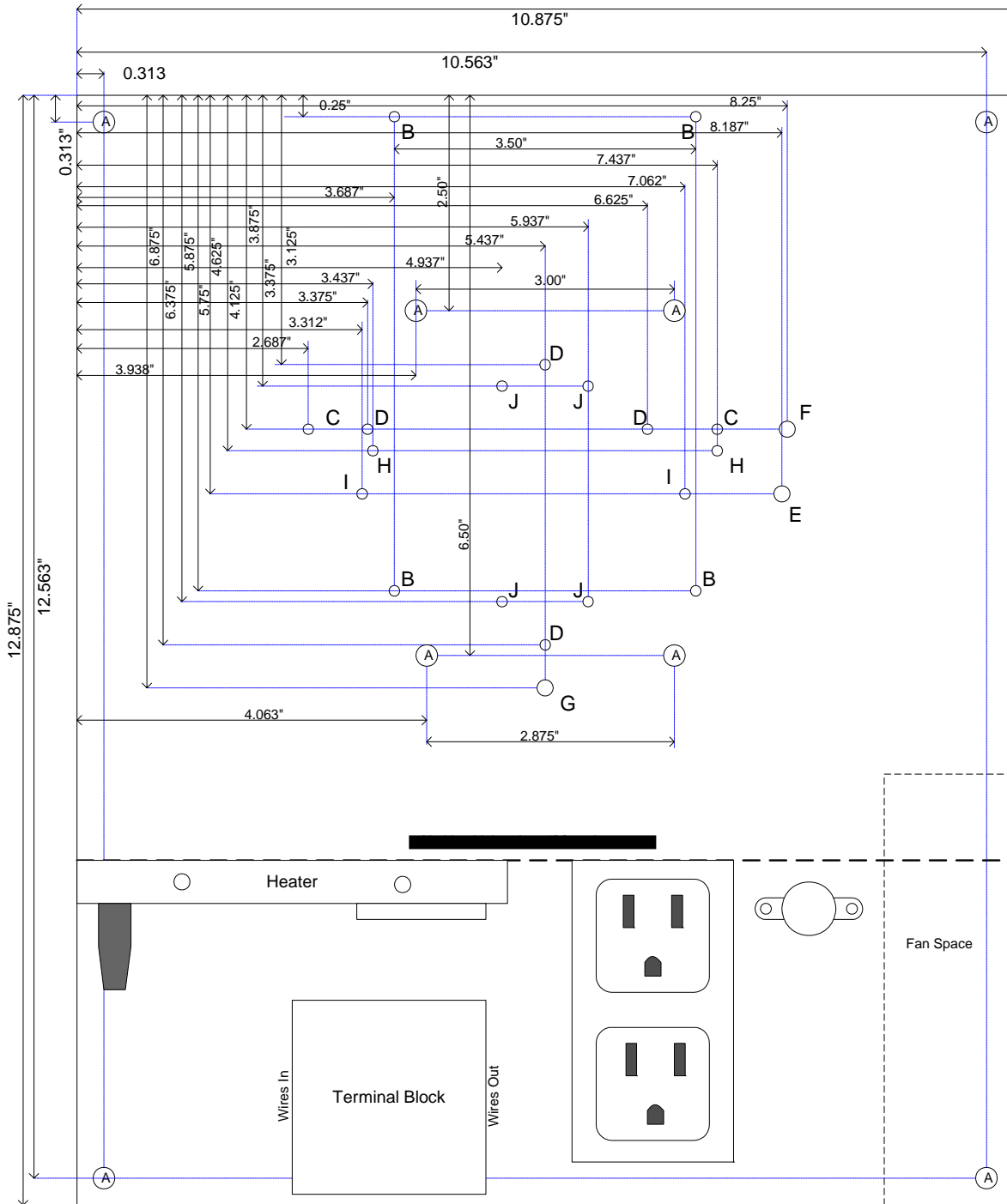

(Figure 1)



Hole Size Chart

<u>Hole</u>		<u>Size & Thread</u>
A	=	7/32" through hole – not threaded
B, C, D, I, J	=	8-32 threaded hole
E, F, G	=	10-32 threaded hole
H	=	6-32 threaded hole

Hole usage ledger

<u>Hole</u>	<u>Used for</u>
A	Mounting holes to mate up with 10-32 thread x 2" standoffs
B	Cisco 350 Metal Case
C & F	Cisco 340 & 350 Plastic Case (F is for 10-32 locking post)
D	Cisco 1200 and 3Com 8250
I & E	Proxim AP (I is for 10-32 locking post)
J	Cisco 1130 AP
H & G	Symbol 4131 (G is for 10-32 locking post)

Customer Provided WLAN/Networking Mounting Screws

<u>Qty</u>	<u>Description</u>
4	10-32 x 3/8" counter sunk – Philips head
4	8-32 x 3/8" round Philips head
2	6-32 x 3/8" round Philips head
1	10-32 locking post (TerraWave has sample)
3	8-32 x 3/8" flat head Philips head

Enclosure Mounting Holes

Mounting holes have been provided in the back of the enclosure. These holes provide easy and convenient mounting of the unit.

Hole Plugs

The enclosure is supplied with pre-installed hole plugs which have been inserted into the mounting holes. These plugs will need to be removed before mounting the unit. The plugs are easily removed by squeezing the lock clips on the inside of the unit. Once the lock clips have been pushed in, the hole plugs will easily slide out of the enclosure. Refer to figure 2.



Attachment

Attach the enclosure to a wall or other structure using customer supplied 3/8 inch fasteners, flat washers and nuts. To insure that the unit maintains proper sealing it is very important to make sure that the fasteners, washer and nuts are tightened thoroughly.

Note: Loose fasteners, washers and nuts may not provide proper sealing and /or securing of the unit.

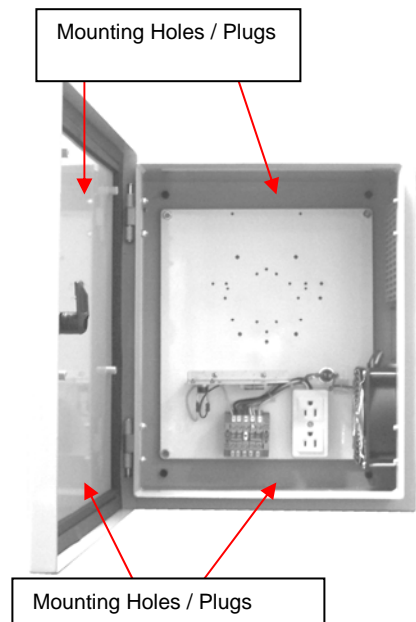

(Figure 2)



Electrical Wiring

NOTE

All electrical connections should be made by a licensed electrician. All local and National codes should be followed as applicable.

Circuit Requirements

The TWSD16128PHC should be connected to a 120V, 15A feeder circuit. The maximum capacity of the power receptacle in the unit is 120V, 12A.

The circuit breaker of the feeder circuit is considered to be the disconnect device for TWSD16128PHC. Therefore, this circuit breaker should be readily accessible. The strain relief (liquid tight cord connector) is suitable for flexible cord with a diameter of 10mm. We recommend using S-W or S-J cord, minimum 16 AWG.

WARNING – TO REDUCE THE RISK OF ELECTRIC SHOCK, DISCONNECT SUPPLY MAINS BEFORE SERVICING.

The supply line used to feed power to the feeder circuit should be rated for outdoor use. Refer to the NEC and local codes as applicable.

WARNING: To prevent the risk of electric shock and equipment damage, disconnect any and all power supply to the enclosure before installing, maintaining or trouble shooting this product or any products inside the enclosure.

Electrical Connection

Before running electrical power to the device, you must first install the cord gland bushing that comes included with the enclosure. Be sure the install the cord gland bushing with the gasket of the outside of the enclosure. Also, the cord gland bushing nut should be tightened snugly by hand. Once the bushing has been tightened by hand then use a wrench to apply an additional quarter turn for final tightening. Do not over tighten the nut – over tightening the nut can result in the cracking of the cord gland bushing. Refer to figure 8.

The electrical wiring should be routed through the cord gland bushing to the terminal block. Refer to wiring diagram – figure 5.

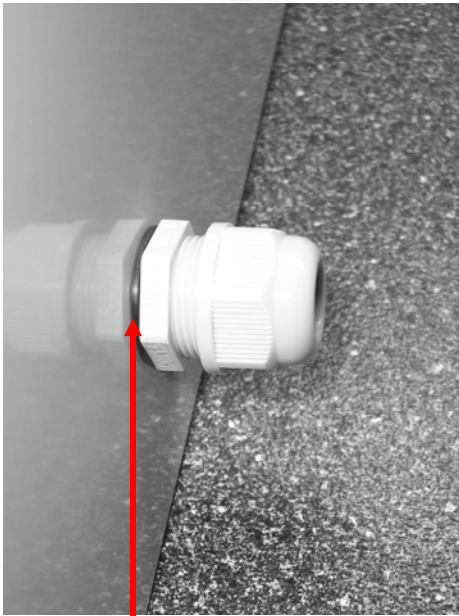

Cord Gland Bushing on outside of enclosure. Ensure that gasket (black) is on outside of enclosure when installing

Figure 8

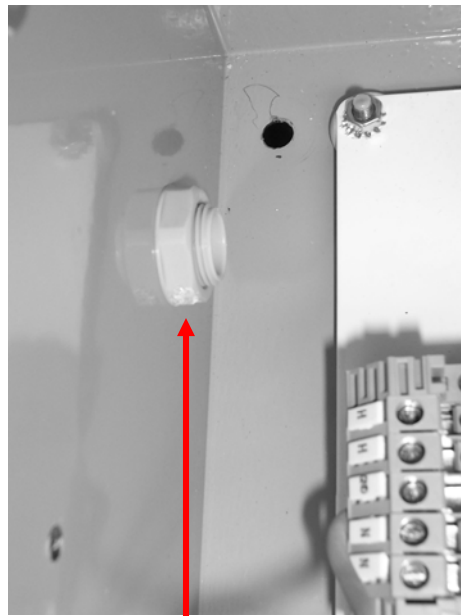

Cord Gland Bushing nut on inside of enclosure.

DO NOT OVER TIGHTEN!

Running Power to the unit

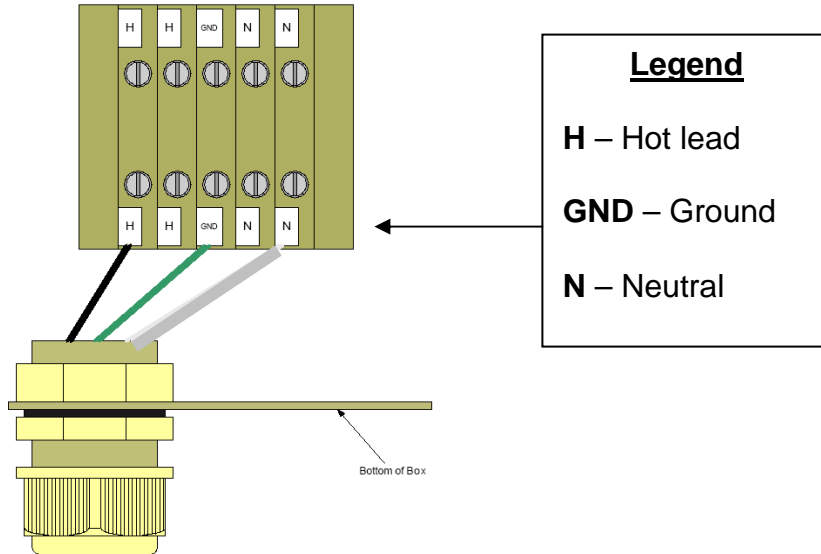

(Figure 5)

Note that all cables need to be rated for outdoor use and wet environments. Refer to the NEC and local codes as applicable.

Figure 5 represents the terminal block and power leads that are wired to the terminal block inside the TWSD16128PHC.

The wiring should be applied as follows:

- 1.) The Black wire in figure 5 represents the hot lead and should be attached to the terminal block that is labeled 'H'.
- 2.) The Green wire in figure 5 represents the Ground connection. The ground lead should be attached to the terminal block that is labeled 'GND'.
- 3.) The Gray wire in figure 5 represents the neutral. The neutral wire should be attached to the terminal block labeled 'N'.